

Ambra 60 Base

Features





- Vanity Base Unit
- Available in 4 Finishes: Glossy White, Nordic Oak, Anthracite, and Samara Ash
- Wall-hung design offers a clean, streamlined look
- Two soft close drawers with hidden parcel extraction runners and organizer in upper drawer
- Fully assembled structure and front made of engineered wood in wood finishes and high gloss lacquered
- Handle integrated in front of furniture
- Does not include vanity top or sink
- Made in Spain



SKU# | Options

- Ambra 60 NO Base | Nordic Oak
- Ambra 60 SA Base | Samara Ash
- Ambra 60 WG Base | Glossy White
- Ambra 60 AN Base | Anthracite

Finishes

-  Nordic Oak
-  Samara Ash
-  Glossy White
-  Anthracite

* WS Bath Collections reserves the right to revise dimensions or information on this sheet without notice

Collection Ambra	Model Ambra 60 Base	Dimensions Metric <i>1 inch = 2.54 cm</i> <i>1 inch = 25.4 mm</i>	 1051 Lea Drive - Collegeville, PA 19426 Tel. 215 513 9400 - Fax 610 831 0215 www.ws bathcollections.com - info@ws bathcollectins.com
----------------------------	---------------------------------	--	---

Technical features

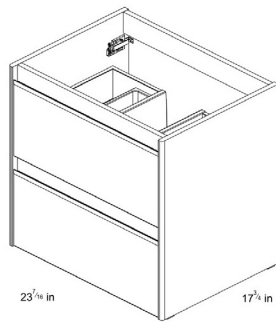

AMBRA
2 Drawers



Nordic Oak



Samara Ash



Gloss White



Anthracite

Technical information

STRUCTURE	MDF board in 5/8 in. continuous wrapping in 2D/ Cyclum Process.
FRONT	MDF board in 5/8 in. continuous wrapping in 2D/ Cyclum Process.
HANDLE	Integrated in the front of the furniture.
DRAWER	Drawers made in mokka textile poly laminate coated board with hidden partial extraction runners with soft close system. Lower drawer useful space (widthxhighxdepth): 20 ^{17/16} x 4 ^{5/16} x 12 ^{2/8} in.
WALL HANGING BRACKET	Hidden hanging bracket of directly assembled with great resistance and depth regulations.
LEGS	Metallic in bright chrome finish. (optional)
PIPE DEPTH	Pipe depth 2 ^{1/34} in.

Collection
Ambra

Model |
Ambra 60 Base

Dimensions Metric

1 inch = 2.54 cm
1 inch = 25.4 mm



1051 Lea Drive - Collegeville, PA 19426
Tel. 215 513 9400 - Fax 610 831 0215

www.ws bathcollections.com - info@ws bathcollectins.com

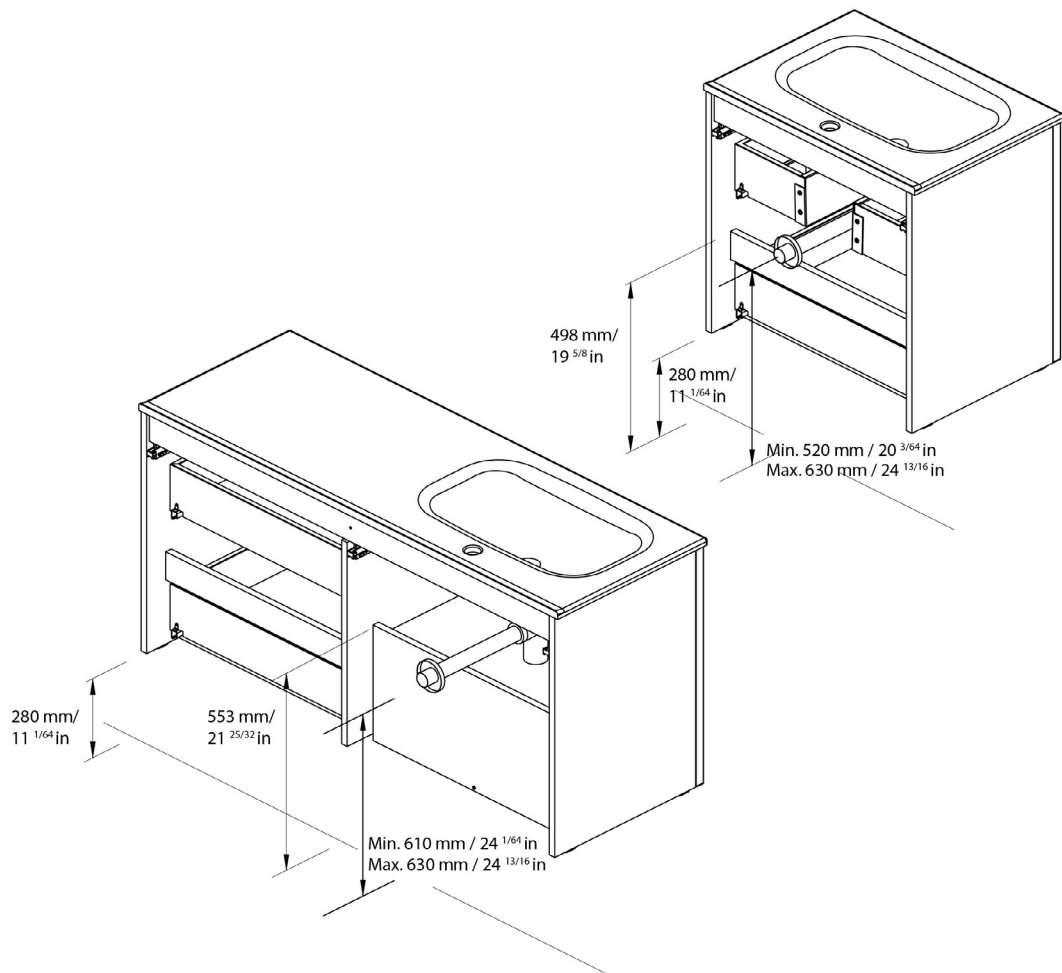

ES EN

Las cotas indicadas en los dibujos son en función de la altura de la pata del conjunto, en caso de que el mueble vaya suspendido y esta altura no se respete, dichas cotas también variarán.

Dimensions indicated in the drawing are based on the level of the whole leg, in case of wall hanging the furniture dimensions also may vary.

<p>Collection Ambra</p>	<p>Model Ambra 60 Base</p>	<p>Dimensions Metric <i>1 inch = 2.54 cm</i> <i>1 inch = 25.4 mm</i></p>	<p>WS[®] BATH COLLECTIONS 1051 Lea Drive - Collegeville, PA 19426 Tel. 215 513 9400 - Fax 610 831 0215 www.ws bathcollections.com - info@ws bathcollectins.com</p>
------------------------------------	---	--	--